

EVOLUTION AIRSOFT

**AIR  
477**

**COMBAT™**  
*series*

**INSTRUCTION  
MANUAL**

MANUALE DI ISTRUZIONI  
MANUAL DE USO

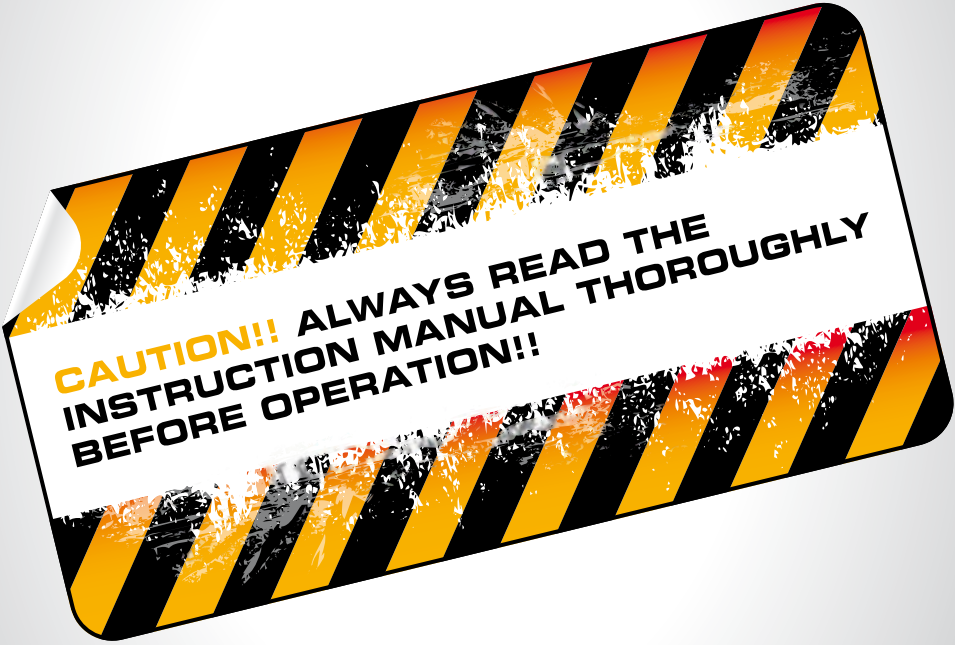

**CAUTION!!** ALWAYS READ THE  
INSTRUCTION MANUAL THOROUGHLY  
BEFORE OPERATION!!

# **AK47** **S E R I E S**

## **INSTRUCTION MANUAL**

**ENGLISH** P. 4  
**ITALIANO** P. 18  
**ESPAÑOL** P. 32

# TABLE OF CONTENTS



# AR47 SERIES MODELS



ENGLISH

MODELS	P. 5
BATTERY INSTALLATION	P. 6
OPERATION	P. 8
MAGAZINE	P. 9
SIGHT ADJUSTMENT	P. 10
HOP UP ADJUSTMENT	P. 12
MAINTENANCE	P. 13
WARNINGS	P. 14
TROUBLE SHOOTING	P. 16

## AR47

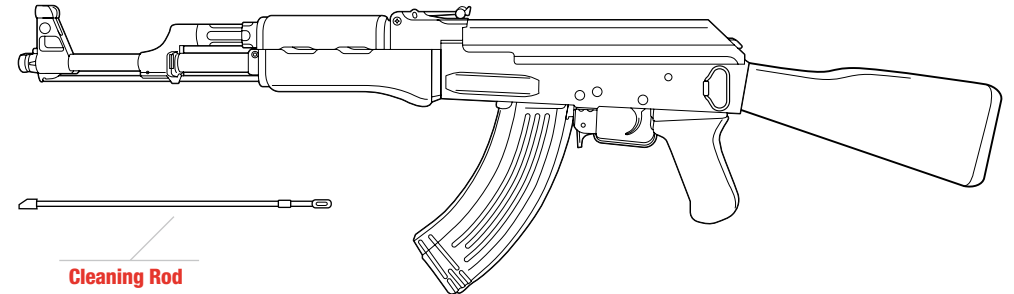

## AR47S

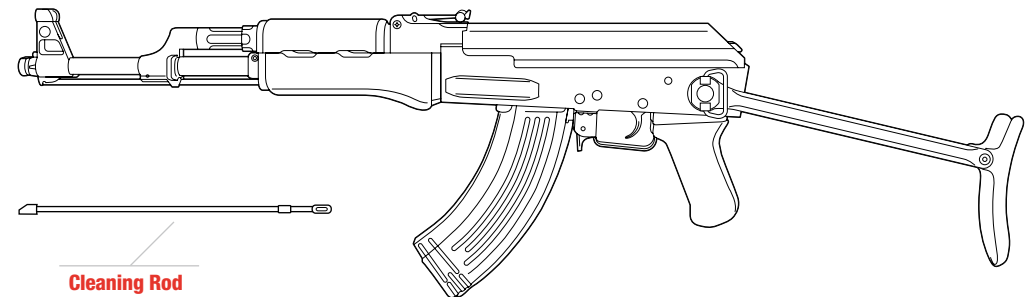

\* Features and configuration may vary according to model and regions.

# AR47 SERIES BATTERY INSTALLATION

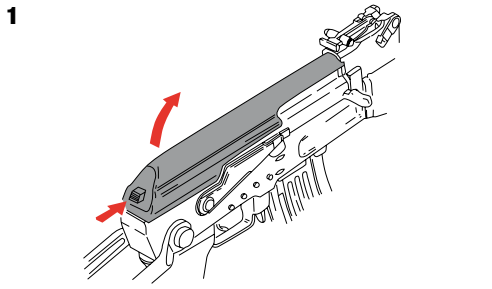

**1** Push the button and **remove the cover.**

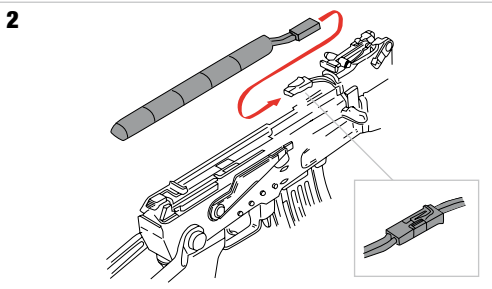

**2** **Connect** the battery connectors.

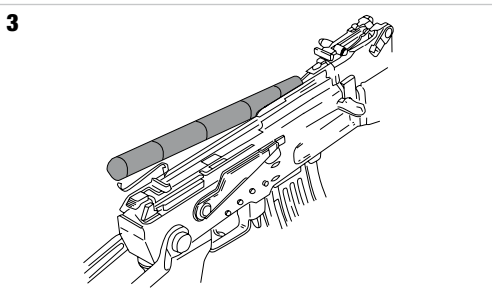

**3** Insert the battery in the compartment **as shown.**

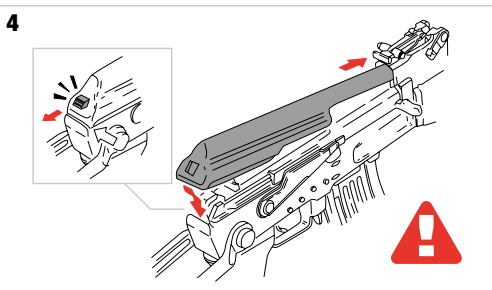

**4** **Reinstall** the cover.

**\* CAUTION!!** Do not **force the cover into place.**

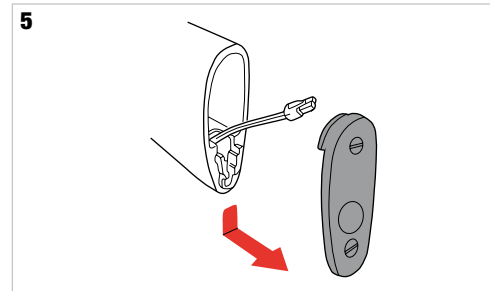

**5** **Slide downwards** to remove the buttstock.

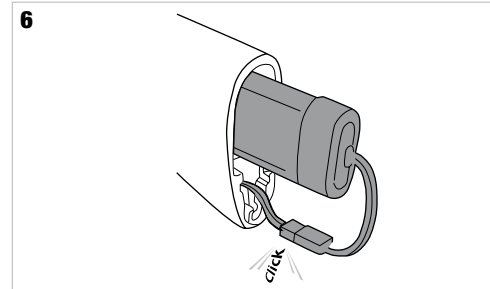

**6** **Connect** the battery connectors.

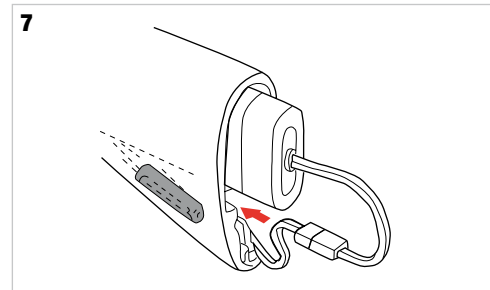

**7** Insert the battery into the stock. **Be careful of wirings.**

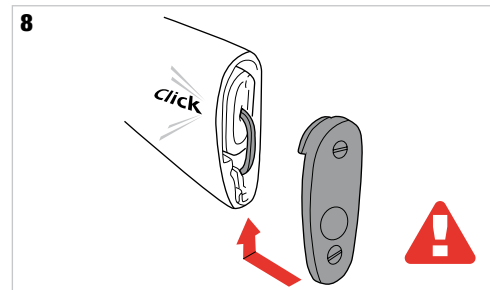

**8** **Close** the cover.

**\* CAUTION!!** Be careful not to damage the wirings.

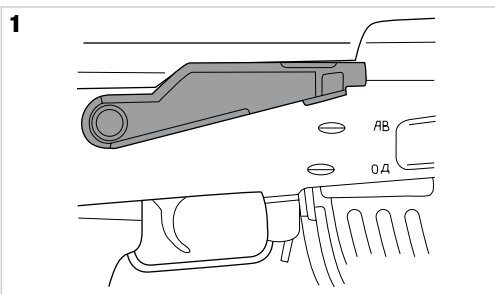

The selector lever allows **three positions:**

**SAFE:** safe on.

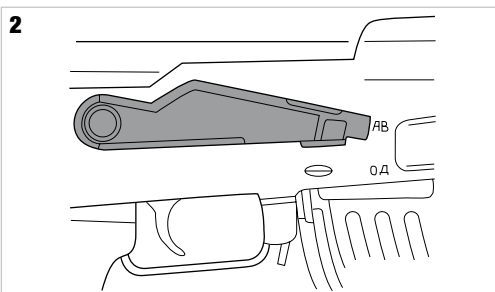

**AUTO:** full auto.

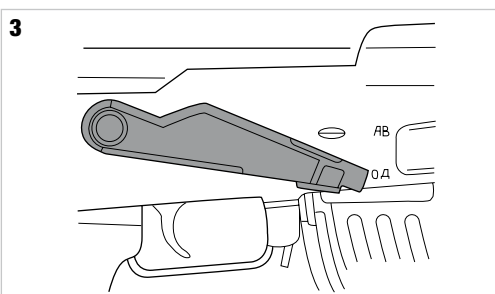

**SEMI:** semi auto.

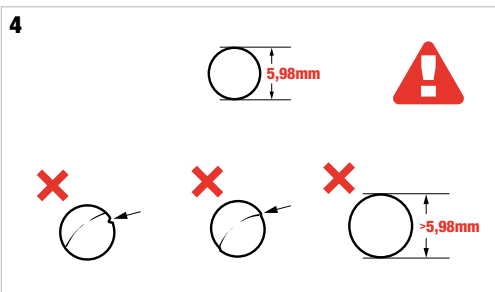

**Use exclusively new 6mm BB pellets is a must. Do not use** any BB pellet which is **not completed**, any **broken** BB pellet and any BB pellet which actual diameter **exceed 5,98mm**.

**\* CAUTION!!** Never use any used BB pellets.

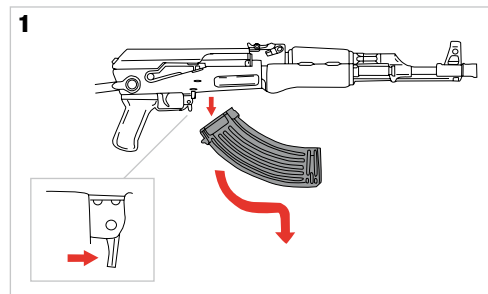

**Press the release button to remove** the magazine.

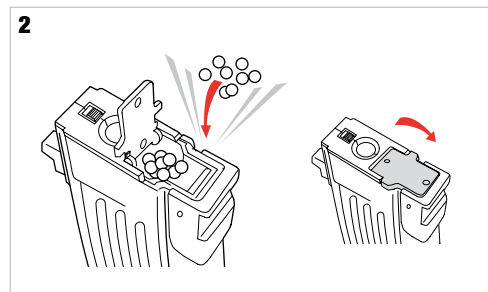

**Open the top hatch** and insert the BB pellets, then **close the hatch**. The magazine capacity is **about 600 BB pellets**. (Avoid forcing BB pellets into magazine.)

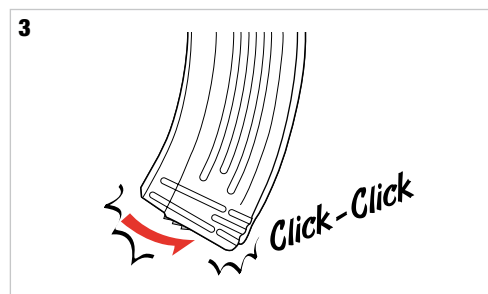

Hold the **BB pellet entrance facing up** and **turn the gear at the bottom** all the way **until the click-click sound changes**. (If only a small number of BB pellets are inserted, the gear merely makes blank turning.)

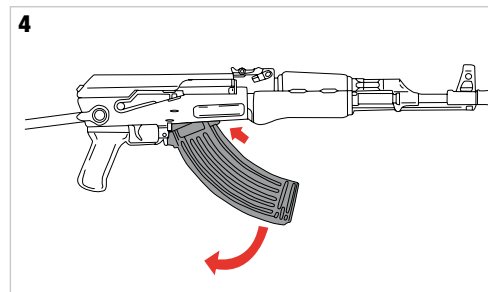

Check the BB pellets are **lifted up to the exit**, and then **connect** the magazine to the gun.

**\* Use exclusively high quality BB's. For the best performance the use of Xtreme Precision®BB's is recommended.**

# AR47 SERIES SIGHT ADJUSTMENT

1

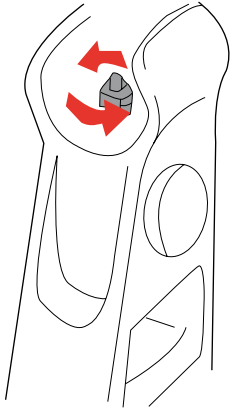

To set the front sight to the point of impact **turn anti-clockwise to move up** the sight and **turn clockwise to move down** the sight.

\* The front sight will come off **if turning too much**.

2

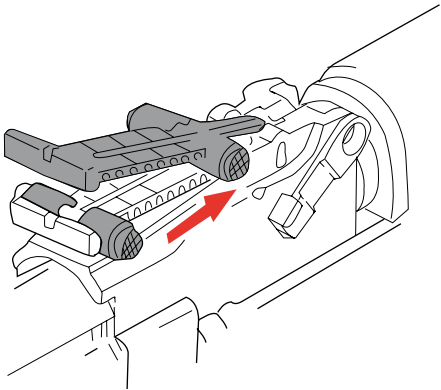

Push the button and **slide forward to rise the point of impact**.

3

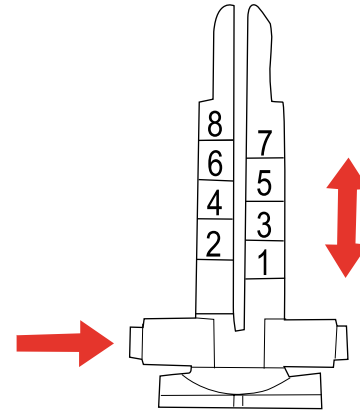

The sight assembly has **reference marks** for easy use.

# HOP UP ADJUSTMENT



# AR47 SERIES MAINTENANCE

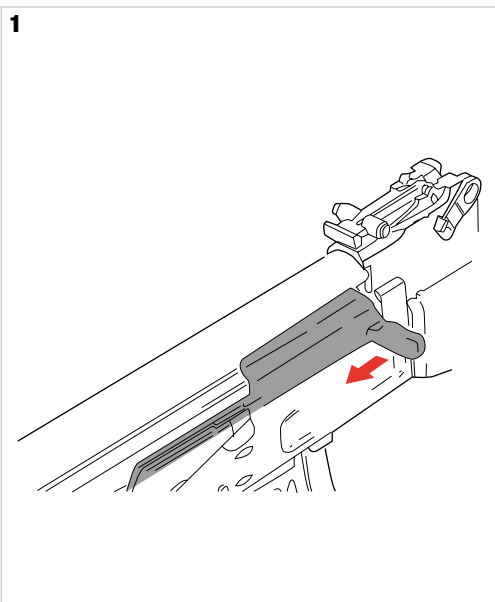

To adjust the Hop-Up **slide back the dummy bolt.**

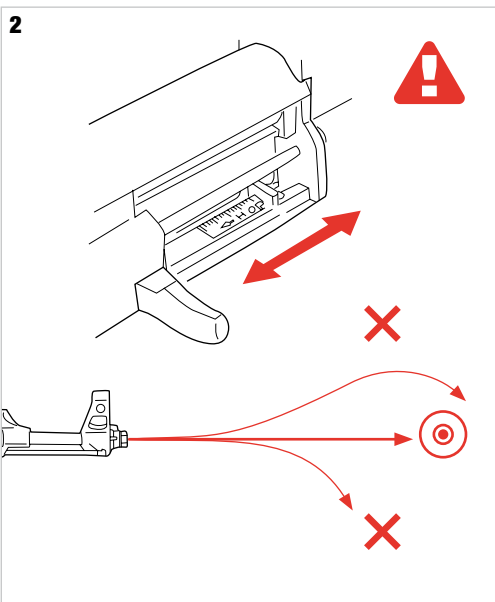

Adjust the Hop-Up using the lever. **The proper setting** of the Hop Up allows a **straight BB's trajectory** and the **maximum shooting distance** without any decrease of accuracy.

**\* CAUTION!!** Ensure that the adjustment cover is **never contaminated by dust and dirt.**

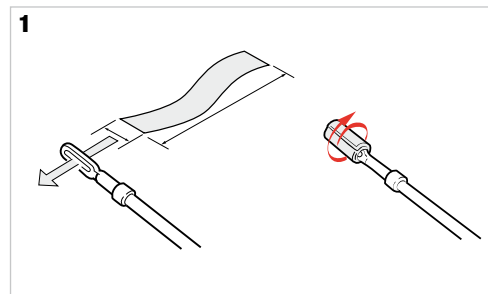

To use the cleaning rod **cut a cotton cloth** to the correct size and **insert one end** into the hole of the rod, then **wind the cotton cloth.** Be careful to adjust the length of cloth for **smooth entry into the barrel.**

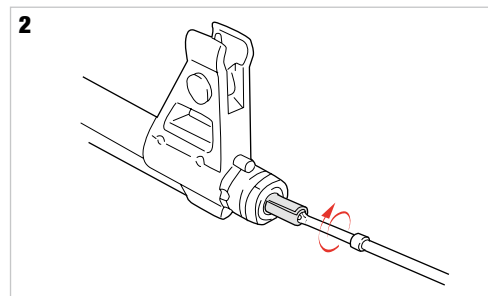

Hold the tip of the rod and **insert with turning motion.**

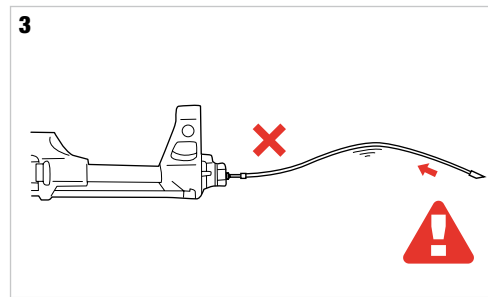

Insert the rod will be difficult if you **hold the rod at the end.**

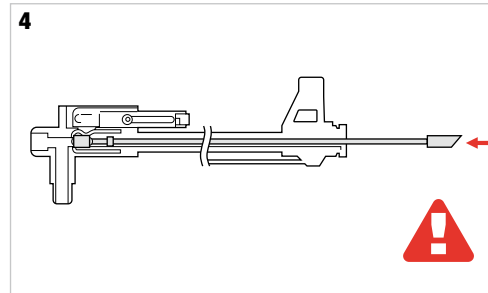

**Spray silicone oil** for 0.5 to 1 sec in the pellet entrance and **clean the oil** from the chamber using the cleaning rod with cotton to complete the maintenance.

**\* CAUTION!!** Always **return the Hop-Up adjustment lever to zero before cleaning operations.** The Hop-Up effect may be unstable for 40-50 rounds after lubing with silicone oil.



# WARNING!!



# WARNING!!



**NEVER DIRECT THE MUZZLE TOWARDS PEOPLE AND ANIMALS.**

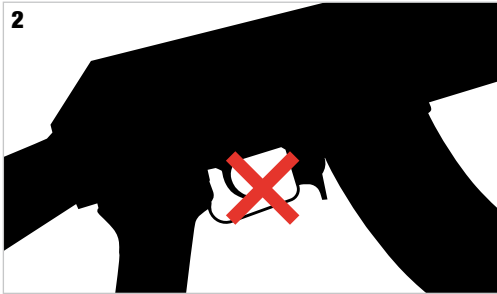

**NEVER PULL THE TRIGGER IF YOU DO NOT INTEND TO SHOOT.**

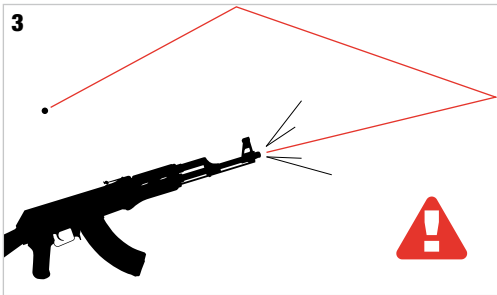

**PAY ATTENTION TO BOUNCING BACK BB'S.**



**KEEP AWAY FOM CHILDREN.**



**NEVER LOOK INSIDE THE BARREL.**

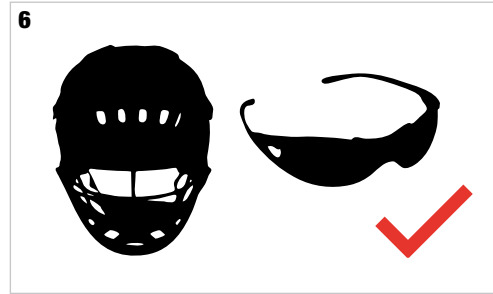

**ALWAYS USE PROPER EYE AND FACE PROTECTION.**



**DO NOT DISASSEMBLE OR MODIFY THE GUN.**

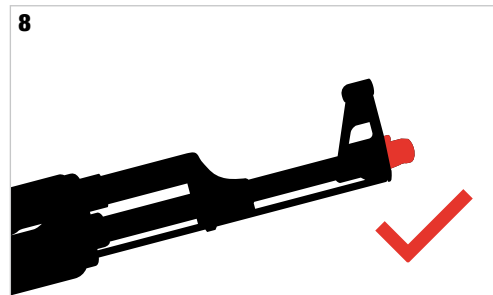

**NEVER REMOVE THE RED/ORANGE COLOR FROM THE MUZZLE.**

# TROUBLE SHOOTING



SYMPTOM	POTENTIAL CAUSE	SOLUTION
<b>No operation at all</b>	Selector lever is set to SAFE.	Set the selector lever to FIRE or AUTO.
	Battery is not charged.	Charge the battery.
	Battery connector is disconnected.	Connect the connector correctly.
	Expired motor life (50,000/60,000 rounds). Blown out fuse.	Replace the exhausted motor (can be purchased from original original Evolution Airsoft spare parts dealers). Change the fuse located in the battery compartment.
<b>Although motor is revolving, no pellet can be fired</b>	Pellets are clogged inside the magazine.	Empty the magazine, shake it and pull the lever to release the spring
	Pellets are clogged in the chamber.	Remove clogged pellets using the cleaning rod.
	Faulty gear or faulty piston.	Change the damaged gear with original Evolution Airsoft spare parts.
<b>The motor tries to revolve but it can't</b>	Insufficient battery power.	Charge the battery.
	Faulty BB pellets.	Use always BB pellets with 5.95 +/- 0.01 mm standard.
	Poor electrical connection.	Consult your dealer for maintenance or repair.
	The + and - of battery connector is reverse.	Connect the connector correctly.
<b>Shooting distance becomes shorter</b>	Damaged or worn out chamber set.	Change the damaged part with original Evolution Airsoft spare parts.
	The Hop Up is not adjusted.	Turn the Hop adjustment lever as shown in the manual.
	Damaged or worn piston set (O-ring, piston spring).	Change the damaged part with original Evolution Airsoft spare parts.
	The barrel is dirty.	Use the cleaning rod and clean the inner barrel.
	Faulty BB pellets (too small or too heavy).	Use always high quality BB's as the Xtreme Precision BB's.
	Shrotage of silicone oil.	Drop few drops of silicone oil spray in the chamber.
<b>Too loud operating noise</b>	Worn out or damaged gear.	Change the damaged gear with original Evolution Airsoft spare parts.
	Gear problem caused by too many blank firing.	Change the damaged gear with original Evolution Airsoft spare parts.
<b>Pellets fall out from barrel end</b>	Damaged or worn out chamber set.	Change the damaged part with original Evolution Airsoft spare parts.
	No Hop Up setting.	Turn the Hop Up adjustment lever as shown in the manual.
	Faulty BB pellets (too small).	Use always high quality BB's as the Xtreme Precision BB's.
<b>If gun gets wet</b>	Stop operation immediately, disconnect the battery, wipe off water from inside the main body and the battery. After completely dry, carry out trial firing. If the unit is not operational, please contact your local dealer for repair.	

# AIR47

## S E R I E S

# MANUALE DI ISTRUZIONI

## DISCLAIMER:

- ▲ Accessories pictured are **not always included** with product.
- ▲ Adult supervision required for users under 18 years of age.
- ▲ The seller and user should conform to all laws governing the ownership of airsoft guns.
- ▲ Excessively long full auto bursts **may damage the mechanical components.**

**FOR MORE INFORMATION AND UPDATES VISIT: [www.evolution-airsoft.com](http://www.evolution-airsoft.com)**

## INFORMATION TO EU USERS:

The trash can symbol means that at the end of its life this product must be disposed of in compliance with the European Laws governing the disposal of electric and electronic waste.



MODELLI	P. 19
INSTALLAZIONE BATTERIA	P. 20
UTILIZZO	P. 22
CARICATORE	P. 23
REGOLAZIONE MIRE	P. 24
REGOLAZIONE HOP UP	P. 26
MANUTENZIONE	P. 27
PRECAUZIONI D'USO	P. 28
RISOLUZIONE PROBLEMI	P. 30

## AR47

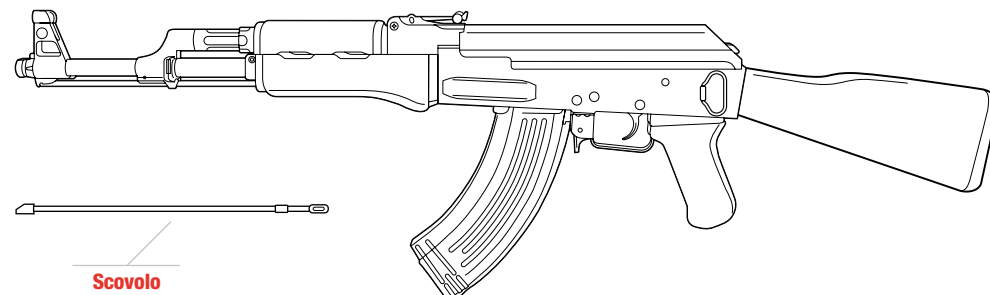

## AR47S

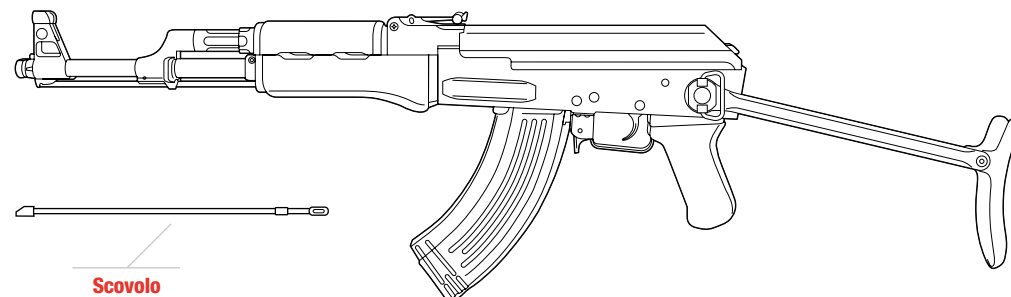

\* La dotazione e la configurazione possono variare a seconda del modello o dei mercati.

# SERIE AR47

## INSTALLAZIONE BATTERIA

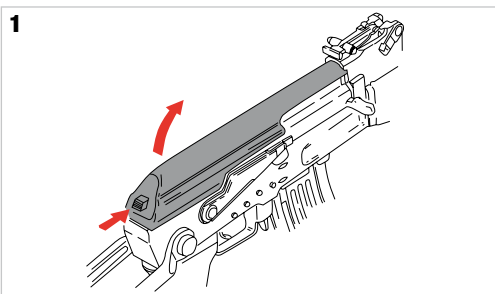

**Premere il bottone** e rimuovere la copertura.

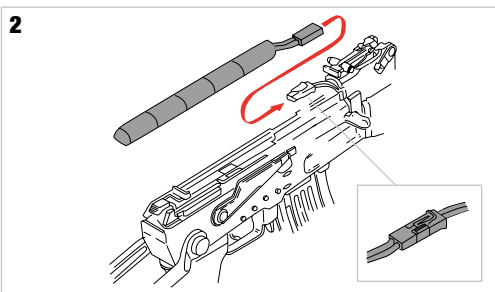

**Collegare i connettori** della batteria.

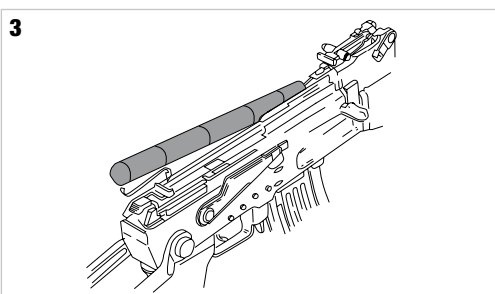

Inserire la batteria nell'alloggiamento come **specificato in figura**.

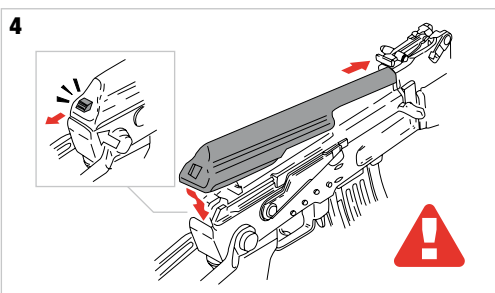

**Reinstallare la copertura.**

**\* ATTENZIONE!!** Non forzare l'inserimento della copertura..

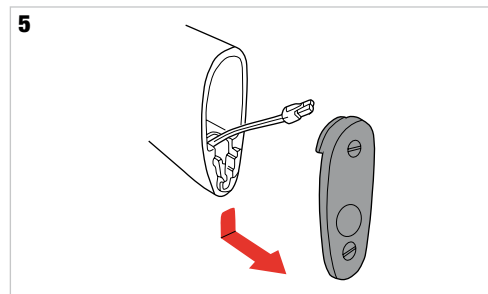

Rimuovere il calciolo **facendolo scorrere verso il basso**.

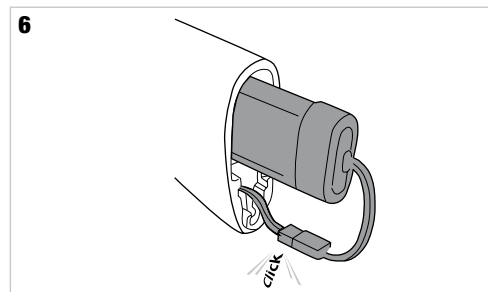

**Collegare il connettore** della batteria.

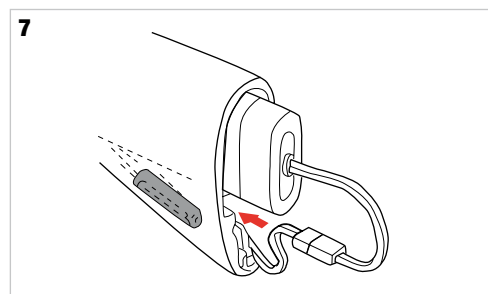

Inserire la batteria **nell'alloggiamento facendo attenzione ai cavi**.

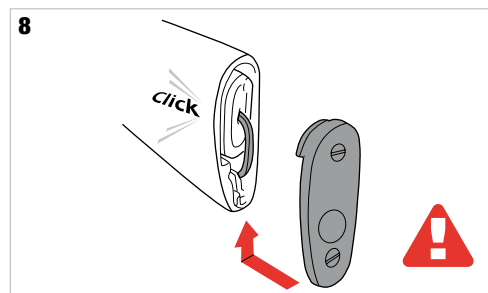

**Riposizionare** il calciolo.

**\* ATTENZIONE!!** Non danneggiare i cavi.

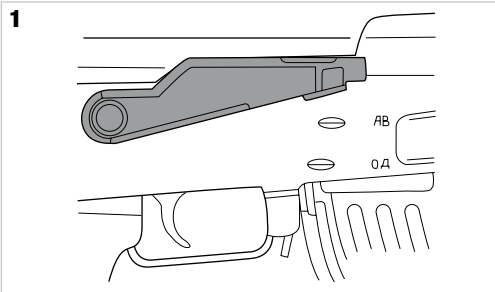

Il selettore di tiro è regolabile su **tre posizioni:**

**SAFE:** sicura inserita.

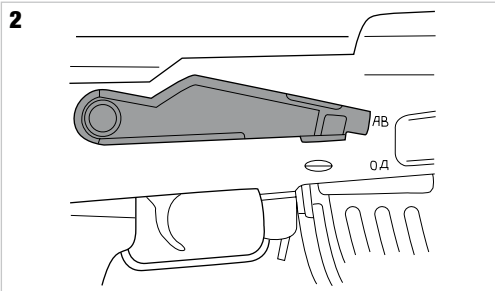

**AUTO:** raffica.

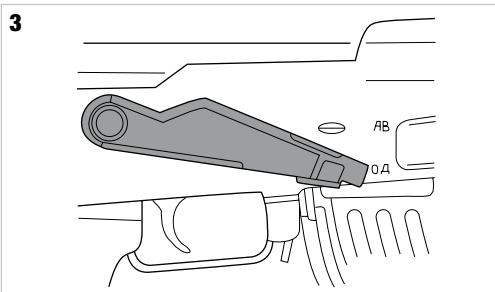

**SEMI:** semi automatico.

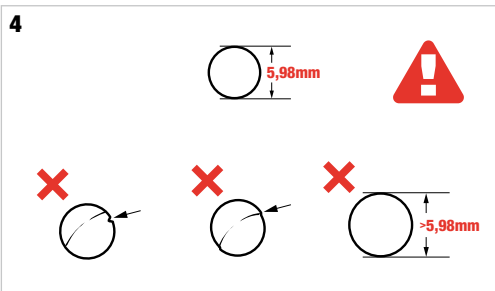

**Utilizzare esclusivamente pallini nuovi. Non utilizzare** pallini che presentano **parti non complete**, pallini **rotti** o con **diametro effettivo superiore a 5,98mm.**

**\* ATTENZIONE!!** Non riutilizzare i pallini.

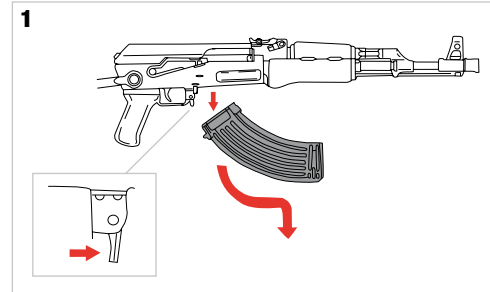

**Premere il pulsante di rilascio** per rimuovere il caricatore.

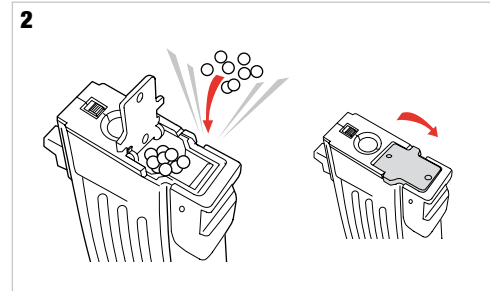

Aprire lo **sportello superiore**, inserire i pallini BB e **richiudere lo sportello**. La capienza è di circa **600 pallini**. (Non forzare l'inserimento dei pallini nel caricatore.)



Tenere il caricatore **rivolto in alto** e girare la rotella posta **sul fondo** fino a sentire il suono click-click che **cambia**. (Se la quantità di pallini è insufficiente, il meccanismo **gira a vuoto**.)

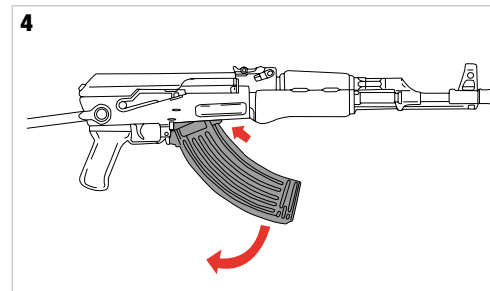

Controllare che i pallini siano **risaliti fino al punto di uscita**, quindi **inserire il caricatore nel fucile**.

**\* Utilizzare esclusivamente pallini di alta qualità. Per le migliori prestazioni si raccomandano i pallini Xtreme Precision®.**

# SERIE AR47

## REGOLAZIONE MIRE

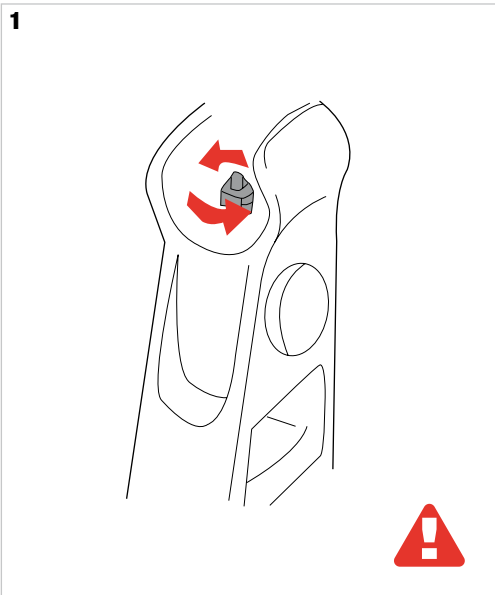

Per collimare il mirino anteriore con il punto d'impatto **ruotarlo in senso antiorario per alzare** il mirino e in **senso orario per abbassarlo**.

\* Il mirino si sfilava se lo si fa **ruotare fino a fine corsa**.

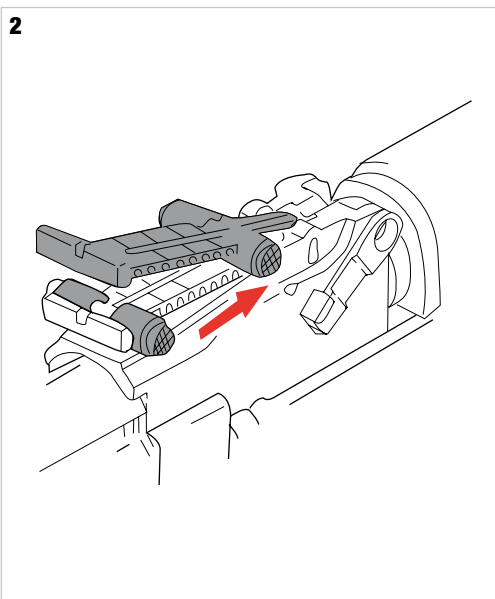

Per collimare il mirino posteriore con il punto d'impatto **premere il pulsante e fare scorrere il cursore in avanti** per alzare il punto d'impatto.

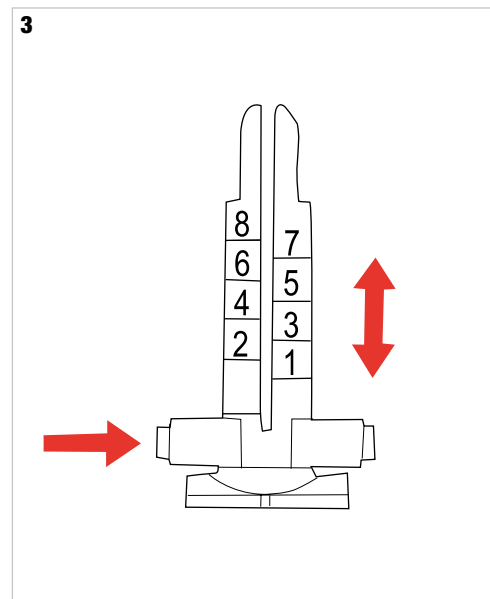

Il gruppo di mira è **graduato** per un più facile utilizzo.

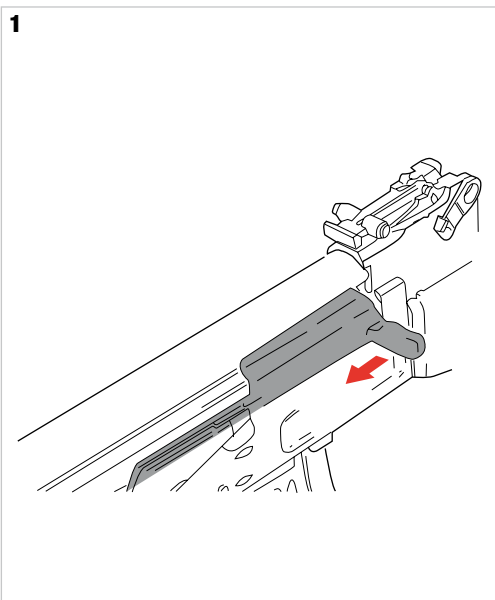

Per regolare l'Hop-Up **arretrare il finto otturatore.**

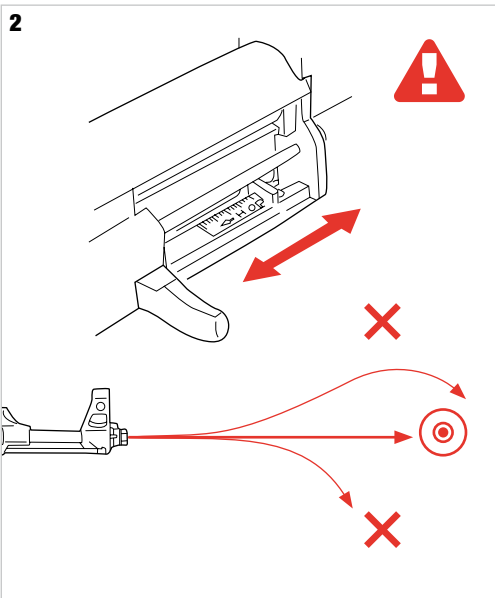

Regolare l'effetto Hop-Up tramite l'apposita leva. **La regolazione ottimale** consente di avere un **tiro teso** e la **massima gittata senza perdite di precisione.**

**\* ATTENZIONE!!** Assicurarsi che il meccanismo di regolazione non venga contaminato da polvere e sporcizia.

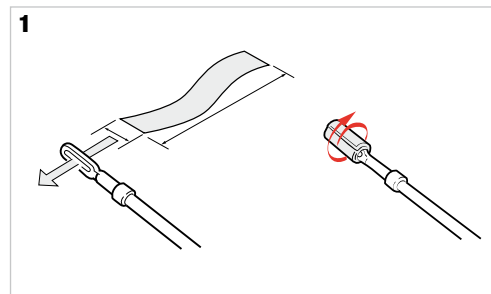

Dopo **ogni utilizzo** pulire l'**interno della canna** utilizzando lo **scovolo in dotazione** avvolgendo all'estremità una striscia di stoffa imbevuta di **olio al silicone spray.**

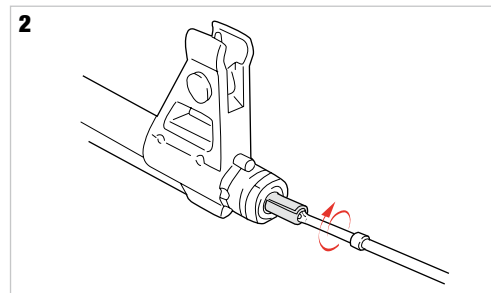

Inserire lo scovolo **con un movimento rotatorio.**

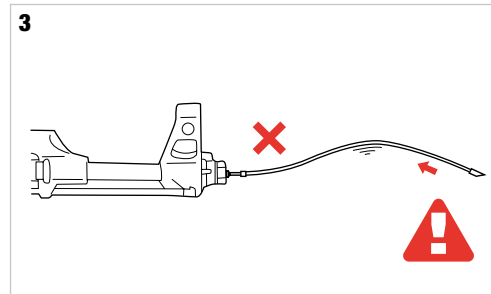

Inserire lo scovolo può risultare difficoltoso **se lo si tiene dall'estremità.**

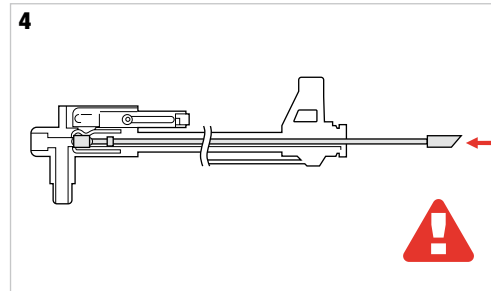

Spruzzare **olio al silicone spray** per 0,5 - 1 sec nell'imboccatura di ingresso dei pallini. **Rimuovere l'eccesso di lubrificante** utilizzando lo scovolo ed un pezzo di tessuto in cotone.

**\* ATTENZIONE!!** Prima di effettuare le operazioni di manutenzione **portare a zero la regolazione dell'Hop-Up.** L'effetto Hop-Up può essere **instabile per 40/50 colpi** dopo la lubrificazione.

# ATTENZIONE!!



# ATTENZIONE!!



ITALIANO



**NON PUNTARE MAI LA CANNA VERSO PERSONE E ANIMALI.**



**NON PREMERE MAI IL GRILLETTO SE NON SI INTENDE SPARARE.**

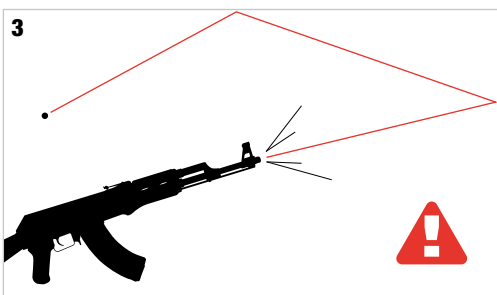

**PRESTARE ATTENZIONE AI COLPI DI RIMBALZO.**



**TENERE LONATANO DALLA PORTATA DEI BAMBINI.**

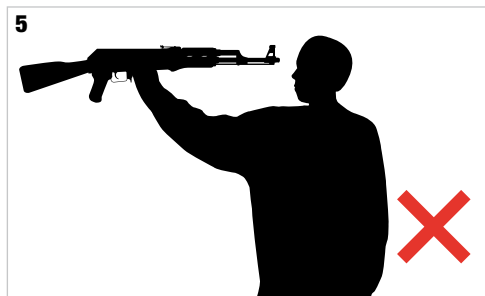

**NON GUARDARE MAI DENTRO LA CANNA PER NESSUNA RAGIONE.**

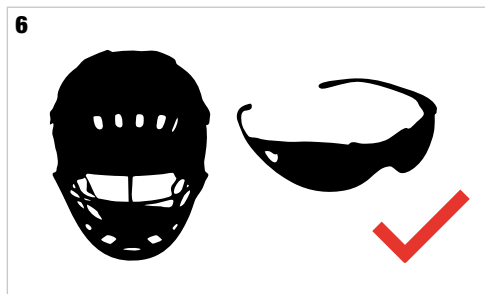

**UTILIZZARE SEMPRE PROTEZIONI PER GLI OCCHI E PER IL VOLTO IDONEE.**



**NON SMONTARE O MODIFICARE IL FUCILE.**

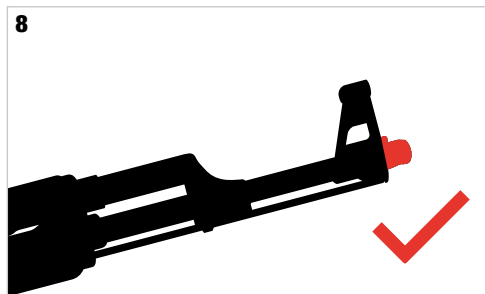

**NON RIMUOVERE PER NESSUNA RAGIONE LA COLORAZIONE ROSSA DALLA VOLATA.**



# RISOLUZIONE PROBLEMI



SINTOMO	CAUSA	SOLUZIONE
<b>Nessun funzionamento</b>	Il selettore di fuoco è posizionato su SAFE.	Posizionare il selettore di fuoco su SEMI o AUTO.
	La batteria non è carica.	Caricare la batteria.
	I connettori + e - della batteria sono disconnessi.	Collegare in maniera corretta i connettori.
	Il motore ha esaurito la sua vita utile (50.000/60.000 colpi).	Sostituire il motore (che può essere acquistato da un rivenditore autorizzato di ricambi originali Evolution Airsoft).
	Fusibile guasto.	Cambiare il fusibile.
<b>Anche se il motore gira, non viene sparato nessun colpo</b>	I pallini sono incastrati nel caricatore.	Svuotare il caricatore, dare alcuni colpi con il palmo della mano sul fondo del caricatore e premere la leva di rilascio della molla
	I pallini sono bloccati nel gruppo Hop Up o in canna.	Rimuovere i pallini utilizzando l'apposito scovolo.
	Gli ingranaggi o il pistone sono danneggiati.	Sostituire le parti danneggiate con ricambi originali Evolution Airsoft.
<b>Il motore cerca di girare ma non ce la fa</b>	La carica della batteria non è sufficiente.	Caricare la batteria.
	Pallini difettosi.	Utilizzare pallini con standard 5.95 +/- 0.01 mm.
	Insufficiente passaggio di corrente.	Consultare un centro assistenza per la riparazione.
	I connettori + e - della batteria sono invertiti.	Controllare che i connettori siano collegati correttamente.
<b>La distanza di tiro è diminuita</b>	Il gommino dell'Hop Up è danneggiato.	Sostituire le parti danneggiate con ricambi originali Evolution Airsoft.
	L'Hop Up ha perso la regolazione.	Regolare l'Hop Up seguendo le istruzioni.
	Il pistone è danneggiato.	Sostituire le parti danneggiate con ricambi originali Evolution Airsoft.
	La canna è sporca.	Usare l'apposito scovolo per pulire la canna del fucile.
	Si stanno utilizzando pallini sbagliati.	Usare solo pallini di alta qualità come i pallini Xtreme Precision BB.
	Il fucile è poco lubrificato.	Mettere qualche goccia di olio al silicone spray nella camera dell'Hop Up.
<b>Eccessivo rumore durante l'utilizzo</b>	Gli ingranaggi sono danneggiati o rotti.	Sostituire le parti danneggiate con ricambi originali Evolution Airsoft.
	Problemi agli ingranaggi causati da troppi spari a vuoto.	Sostituire le parti danneggiate con ricambi originali Evolution Airsoft.
<b>Il pallino cade dalla canna senza sparare</b>	Il gommino dell'Hop Up è rotto o danneggiato.	Sostituire le parti danneggiate con ricambi originali Evolution Airsoft.
	L'Hop Up non è regolato.	Regolare l'Hop Up seguendo le istruzioni.
	Si stanno utilizzando pallini troppo piccoli.	Usare solo pallini di alta qualità come i pallini Xtreme Precision BB.
<b>Se il fucile si bagna</b>	Smettere immediatamente di utilizzare il fucile e scollegare la batteria. Dopo averlo completamente asciugato, sparare alcuni colpi di prova. Se il fucile non funziona, contattare l'assistenza o il rivenditore per la riparazione.	

# AIR47 SERIES MANUAL DE USO

## DISCLAIMER:

- ▲ Gli accessori raffigurati **non sono sempre inclusi** con il prodotto.
- ▲ Per l'utilizzo da parte di minori di 18 anni è richiesta la supervisione di un adulto.
- ▲ Il rivenditore e l'utente, per l'utilizzo del prodotto devono attenersi alle leggi locali.
- ▲ Raffiche eccessivamente prolungate **possono danneggiare** le parti meccaniche.

**PER MAGGIORI INFORMAZIONI O AGGIORNAMENTI: [www.evolution-airsoft.com](http://www.evolution-airsoft.com)**

**INFORMAZIONE AGLI UTENTI:** Ai sensi dell'art. 13 del Decreto Legislativo 25 Luglio 2005, n. 151 "attuazione delle direttive 2002/95/CE e 2003/108/CE, relative alla riduzione dell'uso di sostanze pericolose nelle apparecchiature elettriche ed elettroniche, nonché allo smaltimento dei rifiuti".

Il simbolo del cassonetto barrato riportato sull'apparecchiatura o sulla sua confezione indica che il prodotto alla fine della propria vita utile deve essere raccolto separatamente dagli altri rifiuti. L'utente dovrà, pertanto, conferire l'apparecchiatura giunta a fine vita agli idonei centri di raccolta differenziata dei rifiuti elettronici ed elettrotecnici, oppure riconsegnarla al rivenditore al momento dell'acquisto di una nuova apparecchiatura di tipo equivalente, in ragione di uno ad uno. L'adeguata raccolta differenziata per l'avvio successivo dell'apparecchiatura dimessa al riciclaggio, al trattamento e allo smaltimento ambientale compatibile contribuisce ad evitare possibili effetti negativi sull'ambiente e sulla salute e favorisce il riempimento e/o riciclo dei materiali di cui è composta l'apparecchiatura. Lo smaltimento abusivo del prodotto da parte dell'utente comporta l'applicazione delle sanzioni amministrative previste dalla normativa vigente.



MODELOS	P. 33
INSTALACIÓN DE LA BATERÍA	P. 34
PROCEDIMIENTOS INICIALES	P. 36
CARGADOR	P. 37
MIRAS	P. 38
AJUSTE DEL HOP UP	P. 40
TRABAJO DE CUIDADO	P. 41
ADVERTENCIAS	P. 42
SOLUCIÓN DE PROBLEMAS	P. 44

## AR47

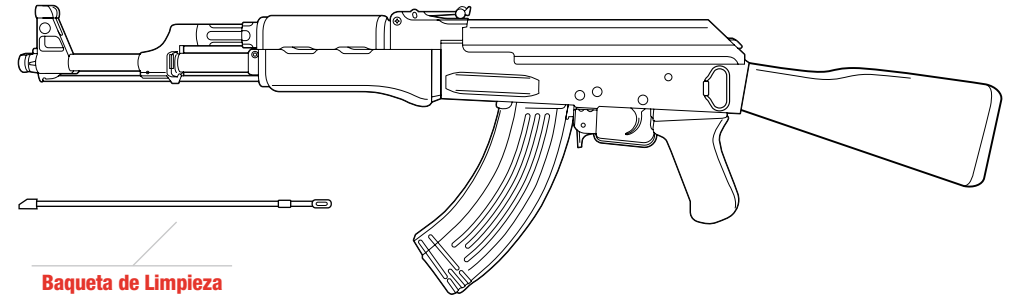

## AR47S

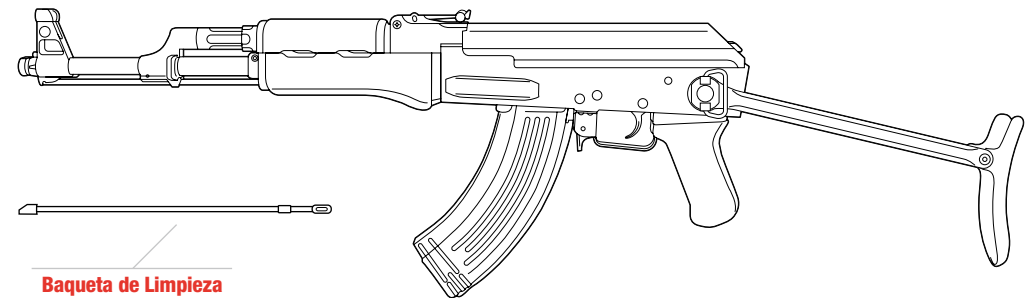

\* La dotación y la configuración pueden cambiar de acuerdo con el modelo o los países.

# INSTALACIÓN DE LA BATERÍA

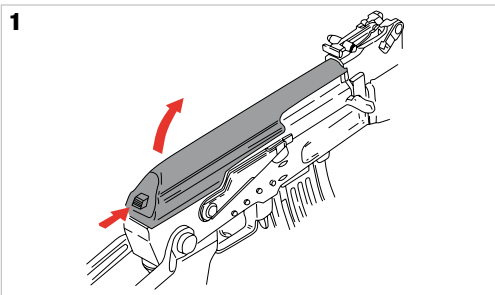

**Apretar el botón** y remover la tapa.

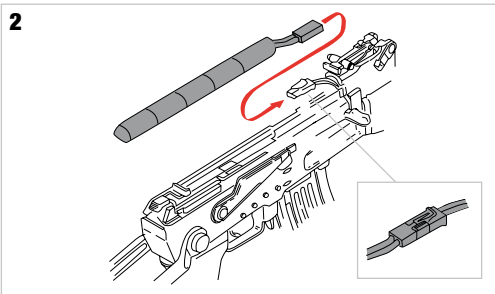

**Conectar los conectores** de la batería.

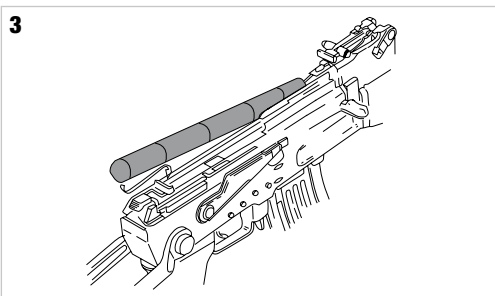

Insertar la batería **en su alojamiento**.

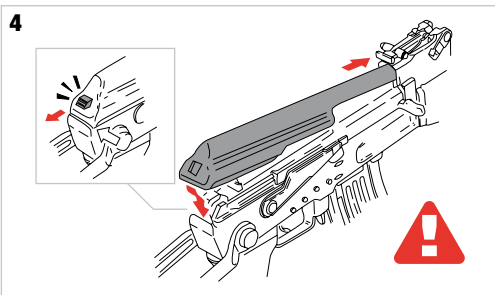

Reposicionar **la tapa**.

**\* ATENCIÓN!!** No forzar la tapa en posición.

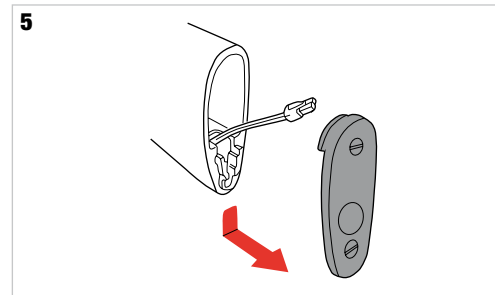

**Remover la tapa de la culata** tirandola hacia abajo.

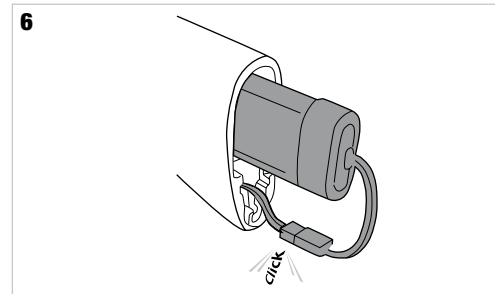

**Extraer** el conector y conectar la batería.

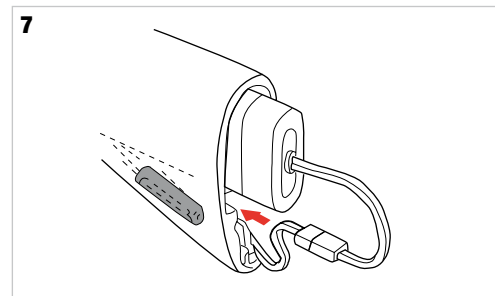

Colocar la batería **en la culata**.

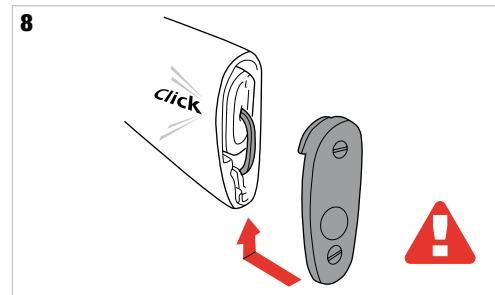

**Cerrar** la tapa.

**\* ATENCIÓN!!** No dañar los cables.

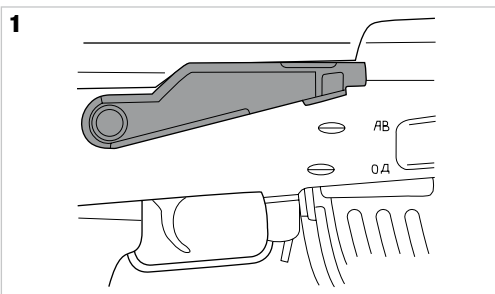

El selector permite **tre modos**:

**SAFE:** seguro armado.

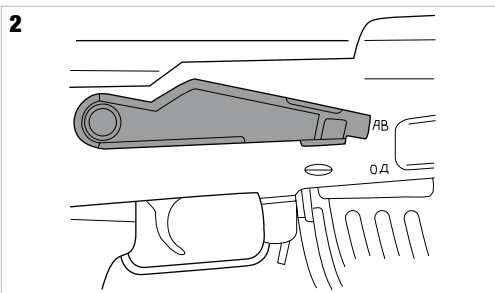

**AUTO:** ráfaga.

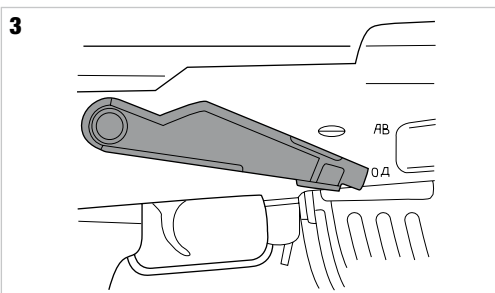

**SEMI:** tiro a tiro.

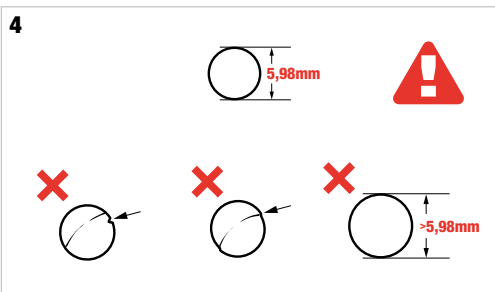

**Usar exclusivamente bolas BB nuevas. No usar** bolas BB **imperfectas, rotas,** o con un **diámetro efectivo mayor de 5,98mm.**

**\* ATENCIÓN!!** No usar bolas BB usadas.

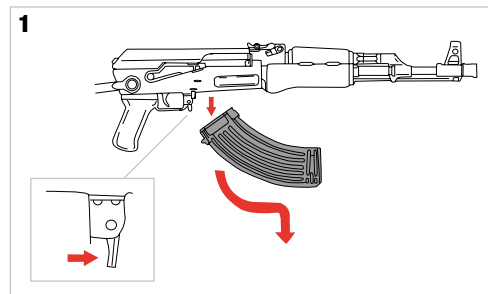

**Apretar el botón** para quitar el cargador.

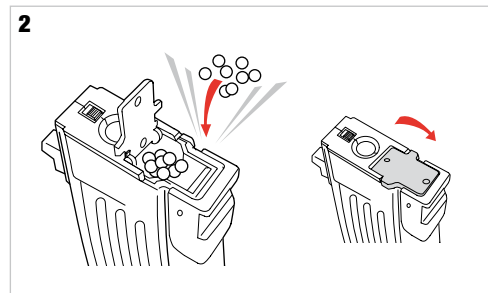

Abrir la ventanilla y cargar las bolas **sin forzar su entrada.** La capacidad es de unos **600 BB'S.**

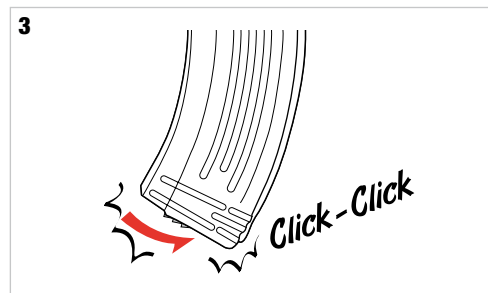

Tener el cargador **como en la imagen** y girar la rueda **hasta que el sonido click-click cambia.** (Si las BB'S non son suficientes la rueda **gira en vacío.**)

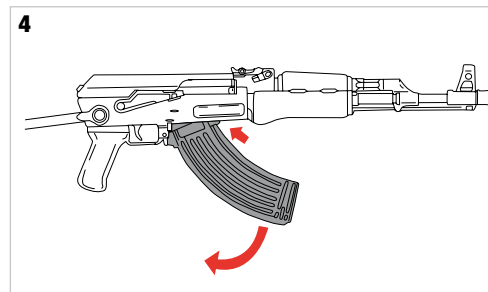

Controlar que las bolas BB **hayan subido hasta la salida** y luego **conectar el cargador al fusil.**

**\* Usar solamente** bolas de **alta calidad.** Para **mejores resultados** recomendamos bolas **Xtreme Precision®.**

1

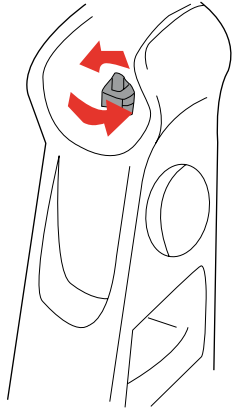

Para ajustar el punto de mira anterior con el punto de impacto **girar a la derecha e izquierda** como en la imagen.

\* Girando demasiado **la mira se quita.**

2

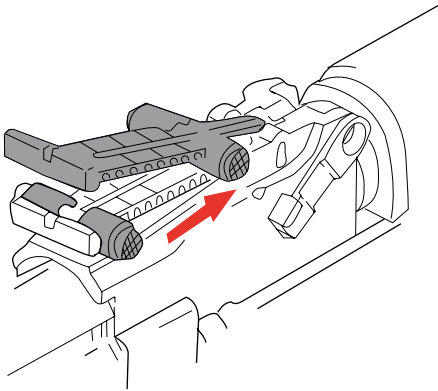

Para ajustar el alza con el punto de impacto **apretar el botón y empujar hacia adelante** para alzar el punto de impacto.

3

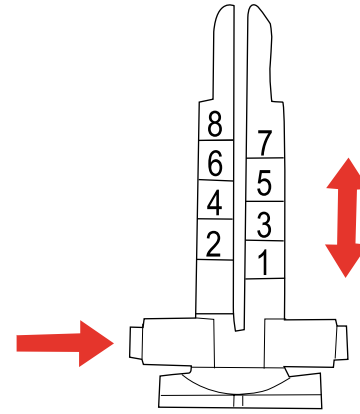

El alza **tiene numeros de referencia** para un uso más facil.

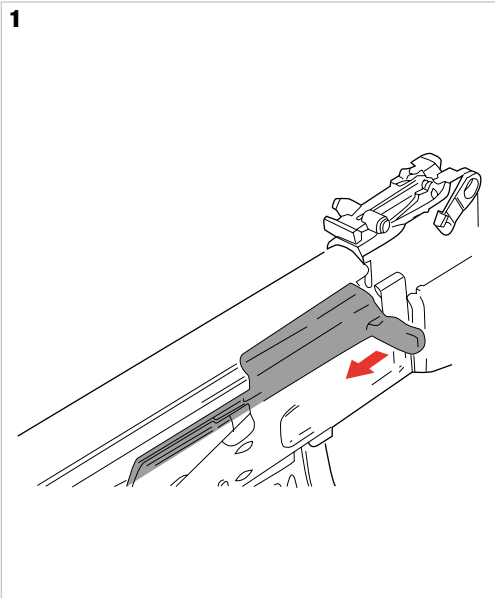

Para ajustar el Hop-Up **retroceder el cerrojo.**

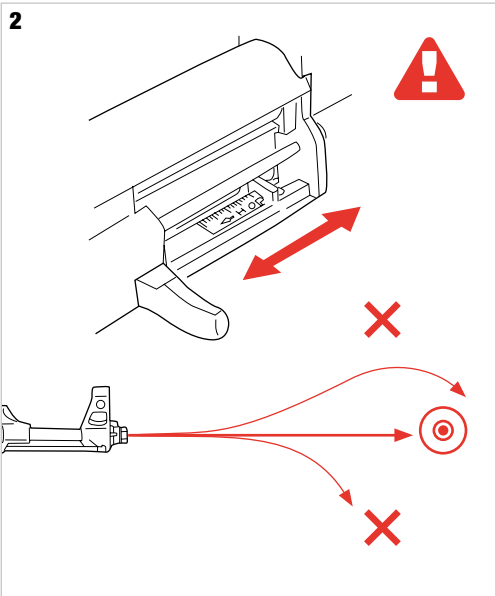

Ajustar el Hop-Up usando su palanca. **Un perfecto ajuste permite tener un tiro tieso y el mayor alcance sin perder precisión.**

**\* ATENCIÓN!!** Asegurarse que los engranajes del Hop-Up no se contaminen con suciedad y tierra.

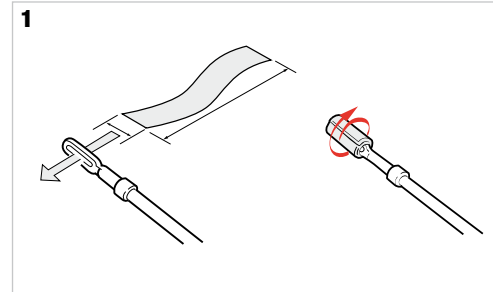

Después de **cada uso** limpiar **adentro del cañón** con su **cepillo** enroscando en la punta un trozo de trapo mojado con **aceite al silicon spray.**

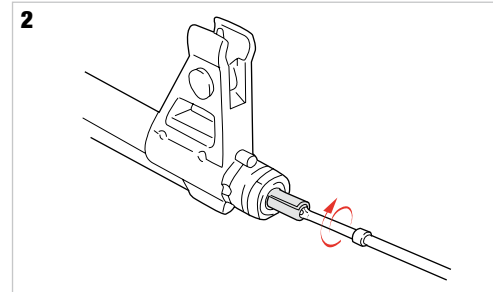

Insertar la baqueta de limpieza **haciendola girar.**

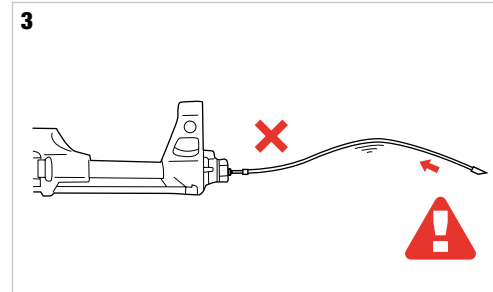

Insertar la baqueta de limpieza es difícil **manteniendola por su extremidad.**

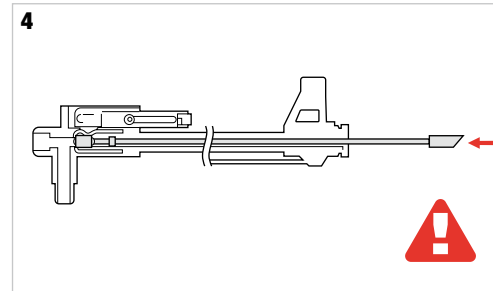

Rociar aceite al silicon spray por 0,5 - 1 segundo **en la entrada de las BB'S** y quitar el aceite usando la baqueta de limpieza y un trozo de trapo.

**\* ATENCIÓN!!** Llevar siempre el Hop-Up en posición de descanso **antes de empezar las operaciones de limpieza.** El efecto Hop-Up **puede mantenerse inestable por unos 40-50 tiros** despues de lubricar con aceite al silicon.

# ATENCIÓN!!



# ATENCIÓN!!



**NO APUNTAR EL CAÑÓN HACIA PERSONAS O ANIMALES.**



**NO APRETAR NUNCA EL GATILLO SI NO SE DEBE DISPARAR.**

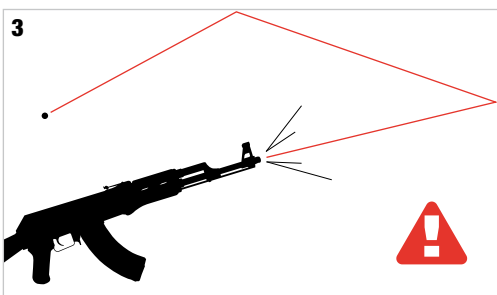

**TENER CUIDADO CON LAS BOLAS DE REBOTE.**



**TENER LEJOS DEL ALCANCE DE LOS NIÑOS.**

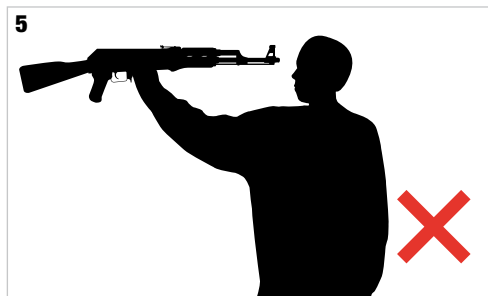

**NO MIRAR DENTRO DEL CAÑÓN POR NINGUNA RAZÓN.**

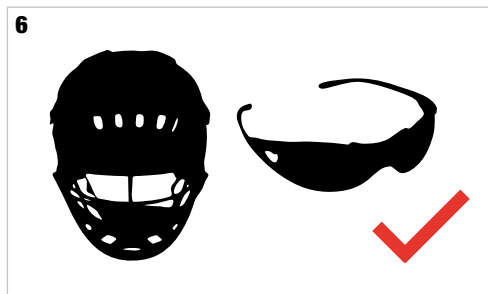

**USAR SIEMPRE BUENAS PROTECCIONES PARA LOS OJOS Y EL ROSTRO.**



**NO DESMONTAR O MODIFICAR EL FUSIL.**

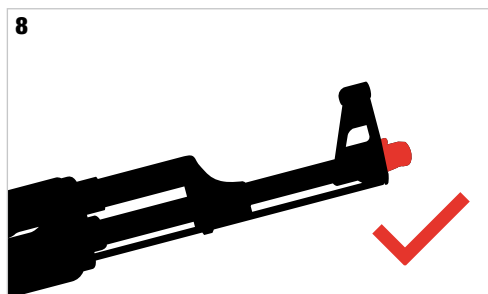

**NO QUITAR PON NINGÚN MOTIVO EL COLOR ROJO DE LA BOCALHA.**

SINTOMA	CAUSA	SOLUCIÓN
<b>Ningún funcionamiento</b>	El selector de tiro está en SAFE.	Poner el selector de tiro en FIRE u AUTO.
	La batería no está cargada.	Cargar la batería.
	Los conectores + y - de la batería están desconectados.	Conectar de manera correcta los conectores.
	El motor se ha agotado (50.000/60.000 tiros).	Cambiar el motor (puede ser comprado en un revendedor autorizado de piezas de recambio originales Evolution Airsoft).
	Fusible quemado.	Cambiar el fusible.
<b>El motor gira pero no dispara</b>	Las bolas están trabadas en el cargador.	Vaciar el cargador, dar algunos golpes con la palma de la mano sobre el fondo del cargador y apretar la palanca de liberación del muelle.
	Las bolas están trabadas en el grupo Hop Up o en el cañón.	Quitar las bolas utilizando su correspondiente cepillo.
	Un rodamiento o el pistón están dañados.	Cambiar la pieza dañada con recambios originales Evolution Airsoft.
<b>El motor trata de girar pero se bloquea</b>	La batería no tiene carga suficiente.	Cargar la batería.
	Bolas defectuosas.	Usar bolas con standard 5.95 +/- 0.01 mm.
	Alimentación eléctrica insuficiente.	Consultar un centro de asistencia para reparación.
	Conectores + y - de la batería invertidos.	Conectar correctamente los conectores.
<b>La distancia de tiro se ha acortado</b>	La goma del Hop Up está dañada.	Cambiar la pieza dañada con recambios originales Evolution Airsoft.
	El Hop Up ha perdido su ajuste.	Ajustar el Hop Up.
	El pistón está dañado.	Cambiar la pieza dañada con recambios originales Evolution Airsoft.
	El cañón está sucio.	Usar su propio cepillo para limpiar el cañón.
	Se están usando bolas equivocadas.	Usar solo bolas de alta calidad como Xtreme Precision BB.
	El fusil está poco lubricado.	Colocar unas gotas de aceite de silicona spray en la recámara del Hop Up.
	Problemas a los rodamientos debidos a demasiados disparos en vacío.	Cambiar la pieza dañada con recambios originales Evolution Airsoft.
<b>Demasiado ruido durante el uso</b>	Los rodamientos están dañados o rotos.	Cambiar la pieza dañada con recambios originales Evolution Airsoft.
	Problemas a los rodamientos debidos a demasiados disparos en vacío.	Cambiar la pieza dañada con recambios originales Evolution Airsoft.
<b>La bola cae del cañón sin disparar</b>	La goma del Hop Up está rota o dañada.	Cambiar la pieza dañada con recambios originales Evolution Airsoft.
	El Hop Up no está bien ajustado.	Ajustar el Hop Up siguiendo las instrucciones.
	Se utilizan bolas demasiado pequeñas.	Usar solo bolas de alta calidad como Xtreme Precision BB.
<b>Si el fusil se moja</b>	Dejar inmediatamente de usar el fusil y desconectar la batería. Luego de haberlo secado completamente disparar algunos tiros de prueba. Si no funciona llamar el centro de reparaciones o el revendedor.	

## DISCLAIMER:

- ▲ Los accesorios representados **no siempre están incluidos** con el producto.
- ▲ Para el uso por parte de menores de 18 años es necesario el control de un adulto.
- ▲ El revendedor y el usuario para el uso del producto están sujetos a las leyes locales.
- ▲ Ráfagas demasiado largas **pueden dañar las partes mecánicas**.

**PARA MAYORES INFORMACIONES Y ACTUALIZACIONES:** [www.evolution-airsoft.com](http://www.evolution-airsoft.com)



**ATENCIÓN:** El símbolo del cubo de la basura significa que este producto debe ser reciclado de acuerdo con las leyes europeas.

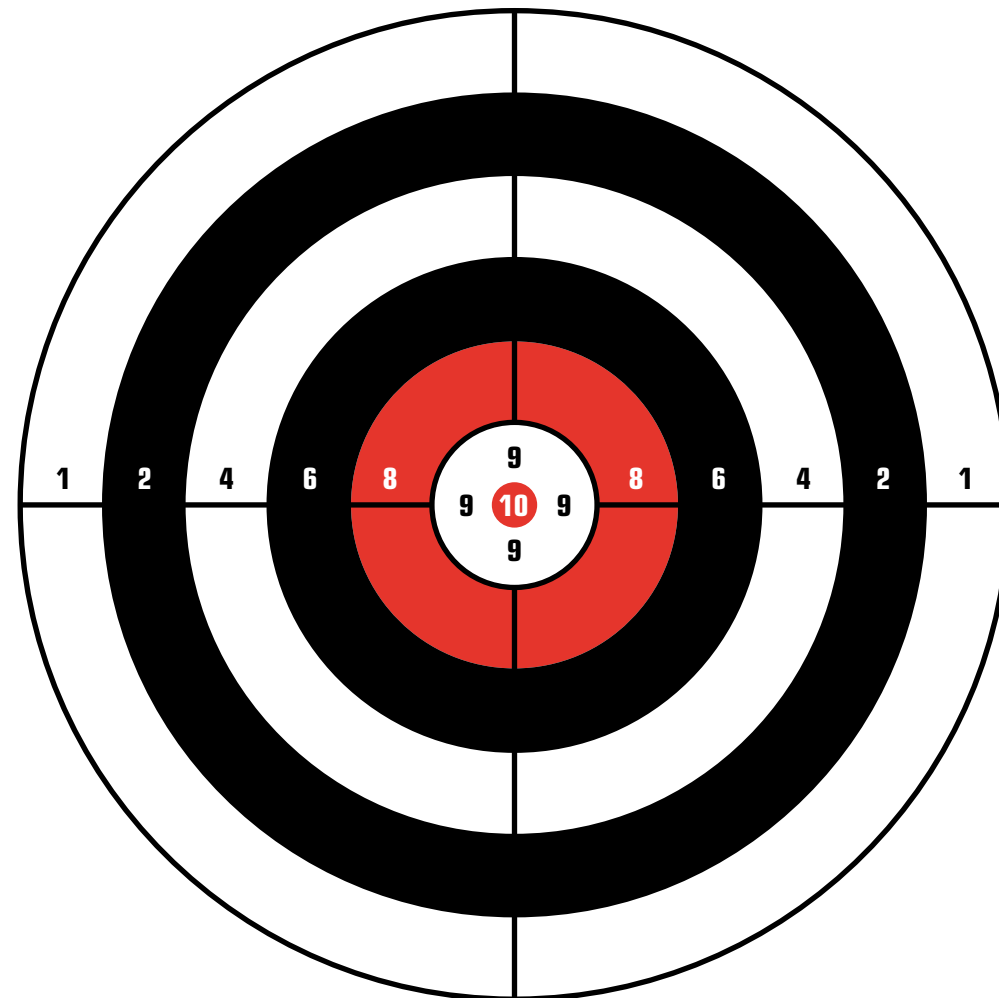

NAME: \_\_\_\_\_  
DATE: \_\_\_\_\_

GUN: \_\_\_\_\_  
BB WEIGHT: \_\_\_\_\_  
DISTANCE: \_\_\_\_\_



# AK47 SERIES

---

COMBAT™  
*series*



Designed in Italy  
by Evolution International S.r.l.  
Made in Hong Kong

[www.evolution-airsoft.com](http://www.evolution-airsoft.com)



Designed in Italy  
by Evolution International S.r.l.  
Made in Hong Kong

[www.evolution-airsoft.com](http://www.evolution-airsoft.com)